

KEEPING CATS SAFE



**How to build cat safe fencing
and cat enclosures**

Acknowledgments

Thanks to the Victorian Department of Primary Industries Bureau of Animal Welfare for permission to use the information from their resource: *How to Build Cat Proof Fencing and Cat Enclosures*.

Thanks to those who assisted the DPI with this information: Bill Plant for preparing the building instructions for the enclosures and netting attachment to fencing and Annabel Woodward and Wendy Height for their contribution to the trialling of the netting attachments to fences.

Disclaimer

The content of this GCCC document is provided for information purposes only. In particular, diagrams are illustrative only and may not be to scale. Information published is considered to be true and correct at the time of publication.

Changes in circumstances after the time of publication may impact on the accuracy of this information and GCCC does not warrant or represent that the information is free from errors or omissions or that the document is wholly appropriate for your particular purposes.

A person using the information should conduct independent enquiries to verify the accuracy of the information. To the extent permitted by law, GCCC, its employees and agents shall have no liability (including liability by reason of negligence) to any person for any loss, damage, cost or expense (consequential or otherwise) incurred or arising as a result of any of the information, whether by reason of any error, omission or misrepresentation in the information or for any action taken by any person in reliance upon the information.

©Gold Coast City Council , Queensland, Australia 2011.

ISBN 1 74146 684 9



Introduction

Cats don't have to roam.

Providing their basic needs are met, cats enjoy longer, healthier lives when safely contained to the property.

Being a responsible pet owner helps keep your cat safe against:

- becoming lost or impounded
- being injured or killed in a road accident, dog attack or fight
- disease
- becoming a neighborhood nuisance

Gold Coast City Council Local Laws require cats be contained to their property at all times.

All cats must be registered and micro-chipped.



Keeping cats contained also protects our native wildlife.

There are some excellent cat enclosures available commercially. However, costs vary and some cat owners prefer to build their own.

This booklet provides instructions for building:

- cat safe fencing by modifying existing fencing to make it 'cat proof' giving your cat free access to parts of, or your entire, yard
- a cat enclosure attached to another structure, such as the house or shed
- a free standing cat enclosure

Most cats adapt well to living indoors and in cat enclosures. Just remember to provide company, affection and enrich the environment to keep cats from getting bored or developing behavioural problems.

Note: Always check with Council before making changes to your property to ensure you abide by building and construction legislation.

Environmental enrichment

Cats have some basic needs to stay happy and healthy.

Companionship

Cats need social contact with owners. Set aside time each day to, pat, play with, or groom your cat.

A well-informed owner

Find out as much as you can about cat behaviour and care. There are many books and websites about cat care, indoor housing requirements, and solving behavioural problems.

Talk to your vet about health and nutrition for your cat.

Space

Cats prefer their personal space, which is important to prevent aggression in groups. Each cat requires his/her own area that provides food, water, bed, resting places, litter tray and play area.

Sleeping, resting and viewing areas

Cats like to spend a lot of time sleeping and resting in quiet areas where they feel safe and secure. Cat beds, blankets, towels and, pillows make cosy spots. High sided beds and boxes give cats a sense of privacy. Elevated areas are used to observe their surroundings. These can be provided with platforms, shelves, climbing posts or window ledges. Some cats love to watch birds (you can place a bird bath/feeder outside the window or enclosure), insects (try planting flowers to attract them), and even nature on television.

Food and water

Cats require access to fresh food and water, however make sure bowls are away from the litter tray. You can also give them grass to chew, non toxic varieties such as oats, wheat or rye-grass.

Litter boxes

Each cat requires its own litter box that is big enough for easy access and is located in a safe and private area (if a cat is startled while using the box, he/she may not use that box in future). You may have to experiment to find out your cat's preferences for covered or uncovered boxes, type of litter and depth of litter.

Cats are clean animals, so litter boxes need to be scooped daily, and cleaned with water and non-scented soap once or twice a week. A thin layer of baking soda on the bottom of the box will help absorb odours between scoopings.

Scratching posts

Scratching is a natural behaviour that sharpens claws, stretches muscles and leaves scent marks. Include a scratching post, that can be made from sisal (a coarse natural fibre), carpet, cardboard or wood. Encourage your cat to use the scratching post by putting catnip on it.

Toys and exercise

Exercise your cat through play or take it for a walk on a harness and leash. Cats enjoy toys that move or make noise, as they remind them of prey. Provide a variety of toys they can roll, pounce on, capture and bite. Toys should be rotated regularly to prevent boredom. Simple and cheap toys that are safe include crumpled paper balls, paper bags to explore, cardboard boxes, and toilet paper tubes. You can also buy furry toys that make noises and can be rolled, balls that can be filled with food or treats and sticks with toys dangling from the end of a string.



This document is broken
into three parts -



Cat safe fencing

Page 6



Cat enclosure attached to an existing structure

Page 10



Free standing cat enclosure

Page 16

Cat safe fencing

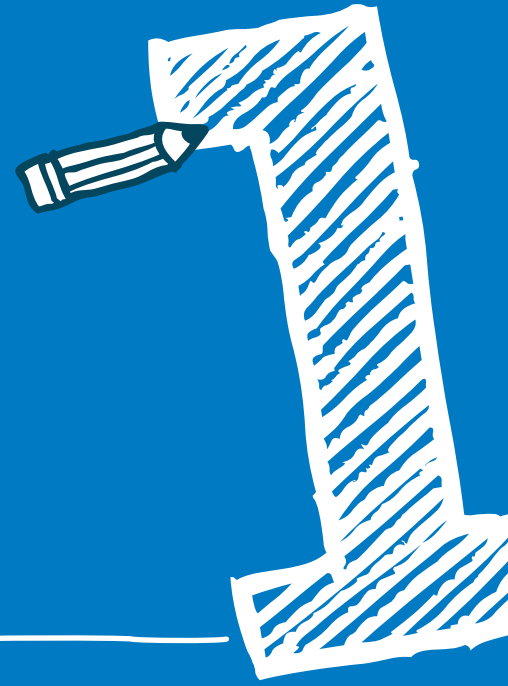

Have you considered cat safe fencing to keep your cat contained?

Modifying existing fencing allows your cat free access to all parts of your yard. See figure 1

This may be a better and cheaper alternative to building an enclosure. An ideal spot is the narrow area between the house and a fence that can be closed off at each end by gates. Enclosing part of, instead of your whole yard, is cheaper and allows space for wildlife to move through your property safely.

✓ Safety

- protective clothing, gloves, and safety equipment must be worn when using and working with construction materials.

Some basic design considerations

Cats need access to the house through a cat door. When they are not able to access the house, they need a weatherproof sleeping area with a bed, and adequate fresh water.

Fence extensions should be entirely on your side of the fence, not directly above the fence, or intruding on the neighbour's side. If they are on top of the fence they need to be amenable to the area and accepted by the neighbour. There must be no dangerous items or sharp edges used in the fencing.

The first step is to seal off all gaps in and under the existing fences and gates. Cats do not usually dig under fences. However, if your cat shares the yard, or is next to a yard with a dog that digs, then you may need a concrete or wooden plinth in the soil under the fence to prevent the dog opening up an escape route. Lock infrequently used gates and fit self-closing springs and latches to all other gates.

If other cats come into your yard, determine if they are able to climb over the cat safe fencing. Most cats should find netting too unstable to climb.

If your cat is escaping remove possible jumping points it may use such as material, equipment or objects near or against the fence.

Trees and shrubs can be trimmed back or a net barrier erected to block access to the launching place. Larger tree trunks can be banded with a 600mm wide piece of sheeting, at least two metres off the ground. (Colourbond steel or clear polycarbonate is ideal). See Figure 2–p7.

Following installation of cat safe fencing, supervise your cat carefully, until you are confident it cannot escape.

Netting

Materials:

- pipe supports – staples or galvanised speed brace;
- soft tie wire;
- wire clips;
- tek screws;
- screws or masonry plugs;
- netting at 900mm width.

Tools:

- cordless drill;
- pliers;
- screw driver bits;
- scissors;
- hammer.

The pipes to support the netting can be made up by a steel supplier from 25mm tubing. Any flexible netting is suitable provided it is strong, UV stable and rot resistant.

The netting used in Figure 1 is similar to a tennis net and has 50mm openings. Ensure holes are small enough so your cat can't get its head caught.

The key to the netting is that it is 'floppy' enough to feel unstable for the cat to climb on. Therefore, avoid using rigid netting such as galvanised mesh.



1 Measure and plan the project

Measure the required length of the 25mm tubing. The pipes will run vertically up the fence, before angling in towards the property (the angled section of the pipe should be 0.7 metres long and on an angle of at least 35 degrees). See Figures 1 and 3.

Netting at this angle is difficult for cats to climb over.

Make sure the changes to the fencing are in line with Council's law.

Calculate the number of supports required, and check prices with your supplier. Pipe supports need to be fitted on fence posts, corners and gates at no more than 2.8 metres apart.

Measure the length and width of the netting required. The netting will be affixed to the existing fencing and to the top of the angled section of pipe.



Figure 1: Completed fence

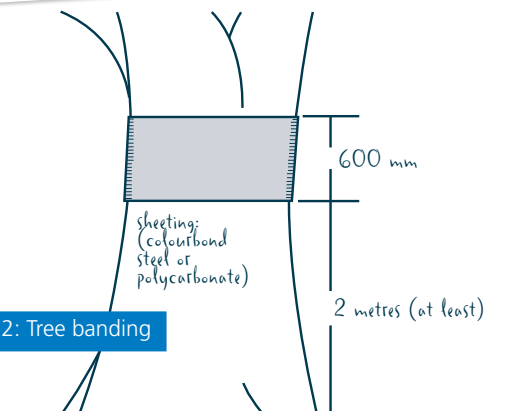

Figure 2: Tree banding

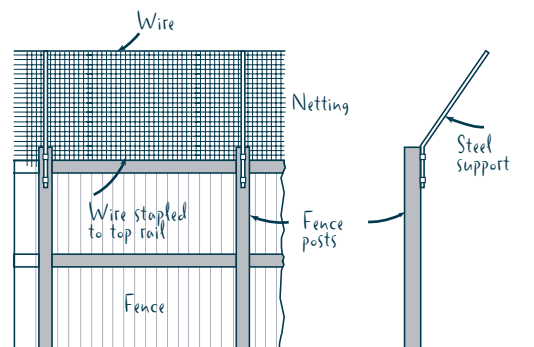

Figure 3: Completed steel support with netting

Continue on next page →

2 Painting



Before you start affixing the pipe supports, paint any non-galvanised steel with metal primer and paint.

3 Affixing

The supports are fixed to the fence with saddle clips or clamps. See Figure 4.



Drill a small hole in the top of each support and run a length of galvanised tie wire around the top through these holes. Fix the netting to the top wire with metal clips. See Figure 5.

The netting can be secured to the top of the fence with staples and a run of wire. See Figure 6.

Staples attach the run of wire to the fence, and metal rings are used to attach the wire to the netting. Ensure the netting is secured to the fence at regular intervals so your cat will not be able to escape by squeezing between the fence and the netting. Alternatively, netting can be attached to the top of the fence using galvanised speed bracing. See Figure 7.

Place netting against the top of the fence and then secure it by applying speed bracing over the top.

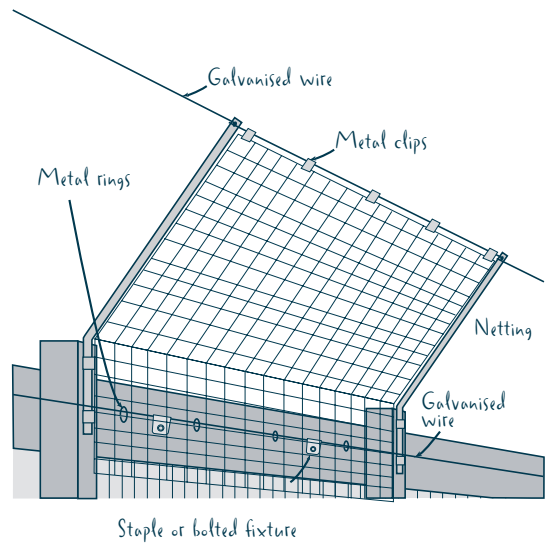

Figure 5: Netting affixed to top wire with metal clips



Figure 6: Netting affixed to fencing with wire

*The content of this Gold Coast City Council document is provided for information purpose only. Information published by Council is considered to be true and correct at the time of publication.



Figure 4: Fixing support pipes



Figure 7: Netting affixed to fencing with brace

Cat containment paddles

Attaching purpose-made rolling paddles to the top of fencing is another way to prevent cats escaping.

Tools:

- variable torque drill driver with extendable Phillips head driver;
- tape measure;
- marking pen;
- mitre box;
- fine-toothed wood saw;
- small hammer;
- small Phillips head screwdriver.

This system has multi-bladed paddles with end brackets that contain bearings allowing the paddles to spin when touched. They are mounted along the top or inside edges of fences. If a cat tries to scale a fence the paddle spins, preventing it from gaining traction.

Rolling paddle attachments can be purchased ready-made and installed on any fence, wall or gate to enclose the entire yard, or section, as long as an unbroken barrier is created around the perimeter. Rolling paddles are durable, unobtrusive and available in many colours

Neighbours may be willing to share the cost and ensuring their cat also remains safely contained on their property.

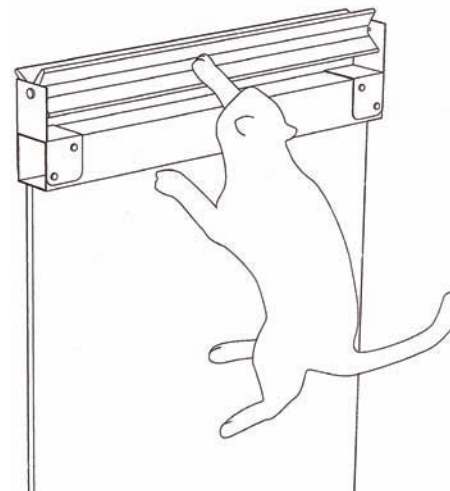

1

Measure



Measure the top of the fences and gates to which the roller paddles will be attached.

2

Prepare



Calculate the number of paddles and components needed, allowing for additional paddles that will need to be cut to fit.

3

Order



Order the paddles and components from the manufacturer or distributor. [See AWL Queensland website.](#)



Cat enclosure attached to an existing structure



There are many options for this type of cat enclosure.

An easy solution is to clad an existing pergola or patio with cat safe mesh, or fit a roof over a small-enclosed area such as a path between the house and fence. If you do not have a suitable area this guide shows you how to build your patio style enclosure from the ground up or a lightweight inexpensive alternative that can be constructed from galvanised water pipe and netting.

Examine your options, then design the project to suit your needs.

Some basic design considerations

- Cats require social contact with owners. This can be achieved by providing access to the house through a cat door or tunnel.
- Cats need shelter from sun, wind and rain and access to sunshine.
- They also need a weatherproof sleeping compartment with a raised bed which must be kept clean and hygienic, with a separate exercise area.
- The litter tray area must be well away from the eating and sleeping areas and must be kept dry and easily to clean. Litter trays must contain an appropriate litter material and be cleaned daily because many cats will not use soiled litter, and will therefore soil elsewhere in the enclosure.
- Disinfectants containing phenol must never be used around cats.
- To prevent disease, worm, vaccinate and de-flea your cat according to veterinary recommendations. Accommodation should provide good ventilation, to prevent build up of odours that can cause respiratory problems.
- Hygiene and odour shouldn't be a problem as long as your cat uses its litter tray and the tray is cleaned regularly. If your cat soils the ground in the enclosure, you may have to consider adding a flooring such as small gauge wire mesh to prevent digging and soiling in the dirt. Or, you could install concrete or timber flooring that is easy to hose.
- Each enclosure should have a scratching pole and at least two platforms at different heights connected by static planks or swinging walkways. Cats should also have access to climbing frames and an interesting visual outlook.
- In a group enclosure, provide a number of hiding and escape areas so cats can avoid aggression.
- The size of your enclosure depends on the number of cats you wish to house, and how well they get on. The floor area must be at least two square metres for each cat, with a minimum height of two metres, plus tunnels and auxiliary enclosures. These dimensions are based on the presumption that cats will also have regular access to the house.

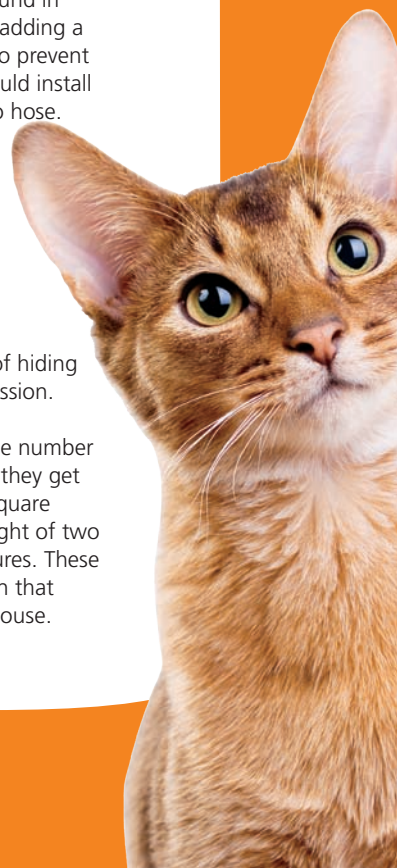

Patio type structure

Material Checklist!

Draw up a working sketch of your project and take it to your local hardware supplier who will advise on the appropriate timber dimensions and spacings you require. Include this information in your drawing and check with council if a building permit is required.

Do not use treated pine as it may be toxic to cats, especially if used as a scratching post. Typical timber dimensions and hardware requirements for an attached pergola approx. 4.8m x 3.6m.



Tools

- drop saw;
- chisel;
- handsaw;
- spirit level;
- drill;
- string line;
- shifting wrench;
- hammer;
- shovel;
- eye protection;
- tape measure;
- hearing protection;
- roofing square;
- ladder;
- tek screw driver, masonry/wood bit.

Materials

- top plate, 1-200 x 50mm;
- framing brackets;
- posts 3-100 x 100mm;
- rafters 6-150 x 50mm;
- braces 2-75 x 50mm;
- post stirrups 3;
- rails 2-75 x 50mm;
- concrete pre-mix;
- wall plate 1-150 x 38mm;
- galvanised nails and bolts;
- joist hangers 3- (attached to the wall plate as per photo);
- battens 45 x 22mm, (typically fitted at 450mm centres).

This shows the basic building structure prior to the addition of solid weatherproof wall cladding on parts of the enclosure (to provide the cat with shelter) and prior to the addition of other features (platforms, climbing planks, scratching posts, beds etc) as described in the text.

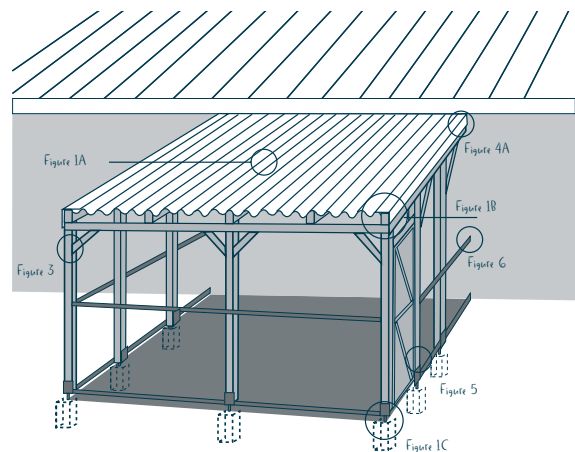

Figure 9: Patio type structure

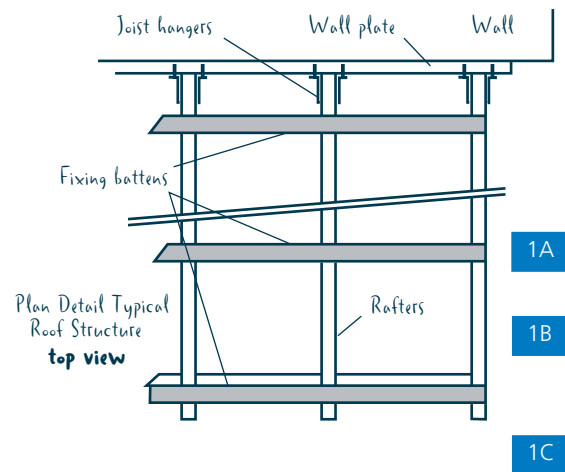

Figure 1: Typical Roof Structure

To span a wide area you will need to consider a typical patio structure - see Figure 9. The most common patio structure involves rafters fixed to the house or garage, and supported at the other end by posts. The posts are connected along the top by a timber plate, which supports the rafters. The best method of setting the posts into the ground is to bolt them in a galvanised stirrup set in a concrete footing. Battens are then nailed across the rafters and the cladding fixed directly to the battens. The basic structure is outlined in Figure 1.

1 Set out

To set out the full size plan on the ground, place a string line parallel to the house along the outside edge of the patio. Set two string lines at right angles to the house at each end of the enclosure. Check the set out is square by comparing corner-to-corner measurements, ensuring they are equal. See Figure 2.

Allow spacing of three metres or less between posts and mark their position along the outer string line. Walk around your set out to check dimensions and proportions.

2 Setting the stirrup post supports

Dig 200 x 200mm holes to a depth of 300mm for each post. See Figure 1C–p11.



Prepare the premixed concrete and fill the holes. Push the post supports into the concrete ensuring the stirrup is above the ground level. This will allow water to drain away from the bottom of the posts and prevent rot.

Align each post support to the string line ensuring they are all level and square.

Leave the concrete to cure to specification.

Drill and bolt the posts in position and secure each post upright with temporary bracing.

House (check in) and bolt the 200 x 50mm timber plate in position across the length of the posts and brace the end posts to the top plate with 150 x 50mm bracing bolted at 45 degrees. See Figure 3.

Please note: if you are fixing the posts onto an existing slab use post supports with a flat plate on the bottom. These are bolted in position with expanding masonry plugs. Your local hardware attendant can show you this method.

3 Attaching a pergola to the house and fixing rafters



Fit a wall plate to the house, fixed to the wall of a brick house under the eaves with masonry plugs, or to a timber house with coach bolts screwed through the weatherboards and into the frame. The rafters are then fixed to the wall plate with joist hangers, and span across to the top plate at approximately 600mm intervals or less and fix with framing brackets or skew nails. See Figure 4A–p13.

4 Fixing battens

Battens are evenly spaced across the rafters at approximately 900mm intervals or less and nailed in position with galvanised nails. Battens should be predrilled to avoid the timber splitting.



5 Access door

The door is a simple brace and rail construction made from hardwood bolted together with galvanised bolts and clad with mesh. The door is hung between two vertical posts with a header bolted across at door height. If there are children consider a childproof latch on the external door. See Figure 5–p13.

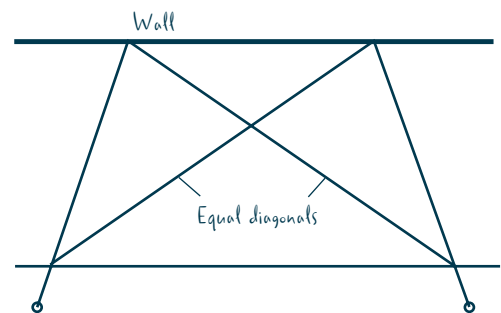

Figure 2: String line set out

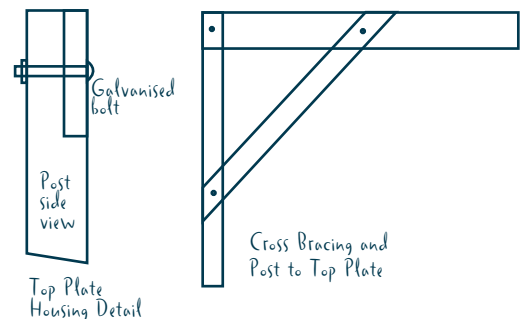

Figure 3: Top plate housing

6 Finishing the timber structure

Remember that treated pine is not an option so seal the timber to protect it from weathering with a good quality exterior finish. Paint the internal faces of the joints before assembly.



7 Roofing/weather proof cladding

It may be a legal requirement that a licensed plumber must fit the roofing and flashing

8 Wall cladding options

Galvanised welded mesh is rustproof and available in a range of sizes and gauges. The maximum mesh size recommended for cat enclosures is 50 x 50mm. A well-fixed four-gauge mesh will provide reasonable security and is strong enough to support climbing plants if you add them. Metal mesh is fixed to the timber posts and timber rails with staples or washers and Tec screws depending on mesh sizes and loading. See Figure 6.

Light flexible mesh is held in position with a timber batten nailed to posts or the existing structure (house or fence). Ask the mesh supplier to advise on the optimum fixing method for your application.



Lightweight 25 x 25mm mesh makes a good barrier where security is not a consideration. The mesh can be fixed with washers and Tec screws.

Galvanised chicken wire is a cheap alternative and is fixed with battens anchored to the base structure.

Shade cloth is available in a range of colours and opacities making it a good option. It has good UV stability and will last for years. However check it regularly for signs of weakness. It is fixed to the structure with special fasteners available from the shade cloth supplier. Shade cloth walls are prone to damage from climbing cats and can be strengthened with metal mesh.

Remember, part of the enclosure must provide access to sunshine, while other areas must give shelter from the sun.

Insect screening can be incorporated into the structure but it needs to be supported by a stronger mesh.

Commercial netting products. Any netting is suitable provided it is strong, UV stable and rot resistant. Access doors can be sewn in with a zip fastener.

Please note: if netting is used to clad the enclosure, a wooden board needs to be set into the ground around the perimeter.

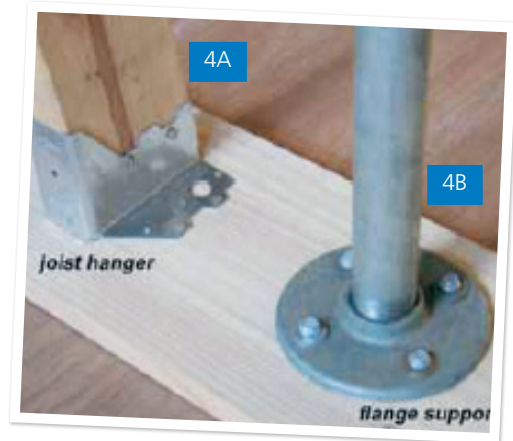

Figure 4A: Fixing method for timber

Figure 4B: Fixing method for galvanised steel tubing

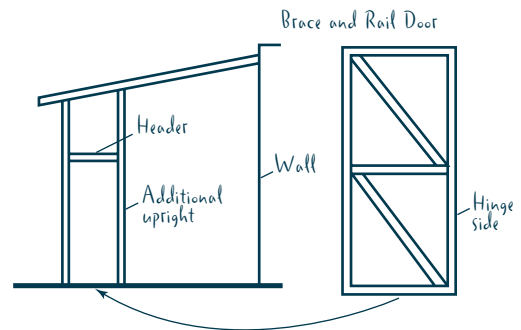

Figure 5: Door detail

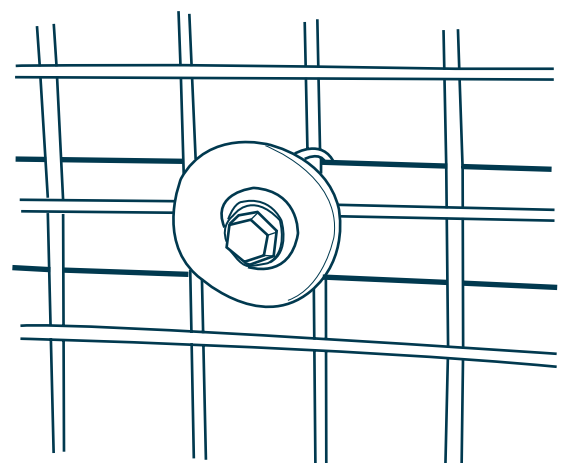

Figure 6: Fixing light mesh

lightweight enclosure

This enclosure is a lightweight alternative intended to be covered with flexible netting and a sewn-in door. The structure will not support a roof and is unsuitable for other mesh cladding.

✓ Tools:

- shovel;
- spirit level;
- drill;
- roofing square;
- masonry or wood bits;
- shifting spanner.

✓ Materials:

- galvanised pipe;
- prefab pipe fitting see [Figure 8](#);
- screw on flanges;
- flexible netting cover;
- coach bolts or masonry plugs;
- tie wire;
- concrete pre-mix.

This enclosure is only suitable for situations where the cat has constant access to the house through a cat door. See [Figure 10–p15](#).

The frame is made from round galvanised steel tubing that is bent at an angle, fixed to the wall at the top, and set in concrete pads in the ground at the other end. See [Figure 7](#).

To provide lateral support, the structure will need to be cross-braced or fixed to something solid, for example a fence.

The recommended wall fitting is a metal flange threaded onto the pipe and fixed to the structure by coach bolts or masonry plugs. See [Figure 4B–p13](#).

The other end of the pipe is set into a concrete footing. Bracing is attached with prefab pipe fittings readily available from your supplier - See [Figure 8](#). The structure can be covered with a prefabricated flexible netting cover with a sewn-in zippered entrance

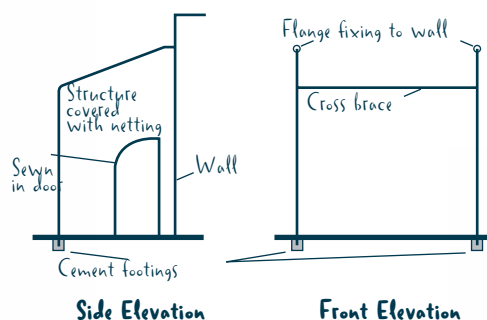



Figure 7: Tubular steel enclosure

1 Basic design

Draw a basic plan and discuss it with your steel supplier who can recommend the optimum pipe diameter, usually around 50mm. Have the pipe cut to length and bent 

Based on your design identify pipes that need to be threaded on the top end to suit the screw-on flanges for fixing and have them threaded at the time of purchase. Most suppliers deliver hard to handle components.

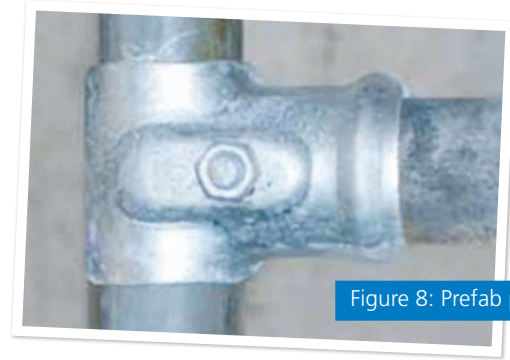

Figure 8: Prefab pipe fitting

2 Set out

Start construction with a string line parallel to the supporting wall at the outside perimeter and another two string lines at right angles to the wall marking each end. See Figure 2-p12.

3 Setting the frame posts

Dig the footings and erect the structure ensuring it is well braced. With a spirit level and a good eye, sight all pipes from all angles to make sure they are aligned with each other and the support structure.

Take care - a poorly aligned frame can look shoddy.

Fit the bracing to square the frame and level the top bars by packing the bottom of the pipes with small rocks in the footing holes. When everything is straight and square, mix up premix cement and pour the footings.

Allow to set to specification.

Set a wooden board into the ground all around the perimeter. The prefabricated netting cover will be fastened to this board.

Measure the finished project for the prefabricated netting.

4 Fixing the netting

Tie the netting to the frame with galvanised tie wire. Fix to wood and masonry with battens, as for patio structure. 

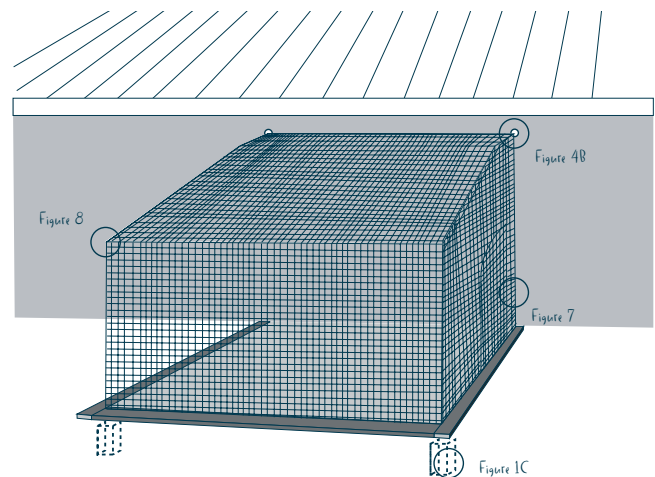
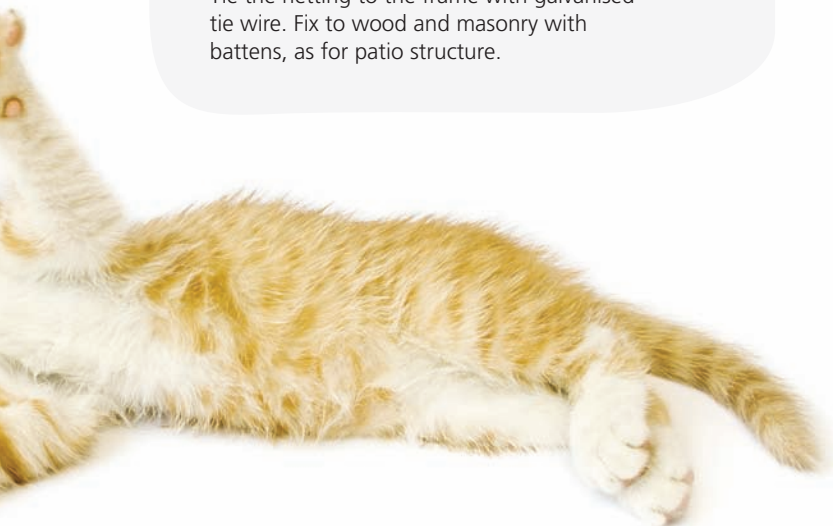

Figure 10: Alternative lightweight enclosure



Free standing cat enclosure



Cats love to move around and keep watch over their territory.

They need a warm dry bed and somewhere to laze in the sun. By building your own cat enclosure you can tailor it to the needs of your cat.

Cats love the variety this enclosure provides, especially when it is linked to the family home through a cat door. To help you design the layout to suit the space on your property there are detailed instructions on how to build a basic enclosure with add on auxiliary enclosures and linking tunnels that can be mixed and matched for the perfect enclosure.

Some basic design considerations.

- Cats must have shelter from sun, wind and rain as well as a sunny spot.
- They must have a weatherproof sleeping compartment with a raised bed kept clean and hygienic, and a separate exercise area.
- The cat litter tray area must be well away from the eating and sleeping areas and kept dry and easy to clean. Litter trays must contain an appropriate litter material and be cleaned daily (many cats will not use soiled litter, and will therefore soil elsewhere in the enclosure).
- Disinfectants containing phenol must never be used around cats.
- To prevent disease, regularly de-flea, worm and vaccinate as per veterinary recommendations.
- Accommodation should provide good ventilation, to prevent build up of odours that can cause respiratory problems in cats.
- Hygiene and odour shouldn't be a problem as long as your cat uses its litter tray and the tray is cleaned regularly. However, in the event of your cat soiling the ground, consider adding flooring of small gauge wire mesh, to prevent cats digging and soiling in the dirt. Or, you could install concrete or timber flooring which is easy to hose down.
- Cats require plenty of social contact with owners. This can be achieved by providing access to the house through a cat door or tunnel.
- Each enclosure should provide a scratching pole designed with at least two platforms at different heights connected by static planks or swinging walkways. Cats should also have access to climbing frames and an interesting visual outlook.
- In a group enclosure a number of hiding and escape areas should be provided to avoid aggression from other cats.
- The size of your enclosure will depend on the number of cats you wish to house, and how well they get on. The floor area of an enclosure must be at least two square metres for each cat, with a minimum height of two metres, plus tunnels and auxiliary enclosures. These dimensions are based on the presumption that cats will also have regular access to the house.

A basic walk-in unit is an essential start to your design and should incorporate a weatherproof sleeping compartment with a raised bed or hammock, and a specific feeding area. Don't forget to provide a separate bowl for each cat. This basic unit can be linked to one or a number of auxiliary enclosures by wire tunnels – see Figure 10 for an example of a finished free standing cat enclosure. The enclosures are made from open welded mesh and can be used to keep the litter tray well away from the main eating and sleeping area.

Base unit

The base unit is constructed around a simple steel frame welded from square section tubing, and includes a walk-in door for cleaning. The unit is clad with a combination of steel sheeting and wire netting.

See Figure 10–p21 for an example of a finished free standing cat enclosure, including a base unit.

If you do not have access to a welder, either have the frame made for you at a local engineering shop, or use prefabricated fittings, available from specialist welding and engineering workshops. They can also supply and cut square steel tubing to suit the fittings which come in a range of configurations, such as tee joint, corner joint, and right angle. The square tubing slips neatly into the joint and is fixed with a self-tapping Tek screw or pop rivet. See Figure 1.

Tools:

- cordless drill and bits;
- f clamps with plastic feet;
- tek screw driver bit;
- angle grinder with cut off and grinding wheels;
- pop rivet gun;
- safety goggles;
- roofing square;
- leather gloves;
- tape measure;
- welder, (note that welding is optional);
- tin snips;
- welding magnets;
- handsaw;
- welding hammer;
- piers;
- welding mask;
- 8mm masonry bit;
- bolt cutters (450mm minimum length)

Materials:

- 25 x 25mm square tubing, primed;
- hinges;
- 25 x 25mm galvanised mesh;
- latch;
- scrap steel offcuts;
- tie wire;
- 50 x 50mm galvanised mesh;
- primer and paint;
- trimdec capping;
- 8mm Dyna-bolt;
- tek screws and washers;
- zincalume or Colourbond fence sheeting;

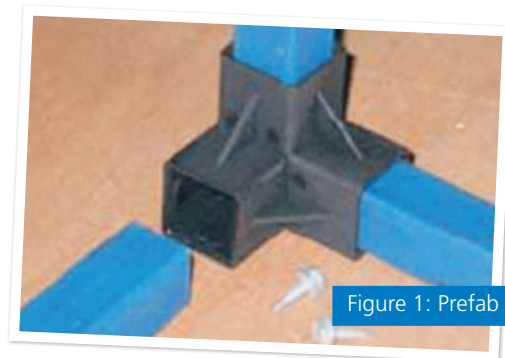

Figure 1: Prefab frame fitting

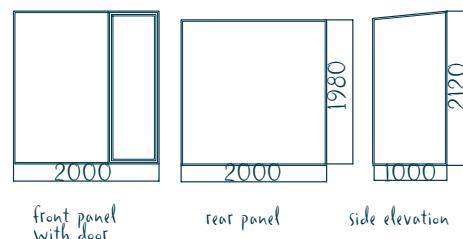

Figure 2: Steel frame for base unit

1

Step 1 - design



First read through the step-by-step instructions to familiarise yourself with the component units and the construction techniques and establish the number and type of units that you require.

Decide on your preferred layout, marking it out with pegs, paint or tape. See "Cat enclosure attached to an existing structure" section, Construction Step 1, for an example of a stringline set out. It is a good idea to leave this set out overnight, and return the next day with fresh eyes and ideas. Once you have decided on your layout, draw a simple plan to work from on 1cm x 1cm square graph paper to give you a 1:100 scale drawing. Use the plan to make up a materials and cutting list and set to work, following the simple step-by-step instructions.

2

Step 2 - prepare a cutting list

Working from your plan, prepare a materials and cutting list. Here is a sample-cutting list that has been taken from the drawing of the basic unit in Figure 2 which constructs an approximate 1 x 2 metre enclosure (which is the minimum size per cat. see "Design considerations" for details).

Prepare a similar cutting list from your plan.



Material 25 x 25mm tubing	Qty	Size
Front panel uprights, door jamb, top and bottom rails	2	2050mm
	1	2050mm
	2	2000mm
Door	2	1980mm
	2	680mm
Rear panel uprights, top and bottom rails	2	1900mm
	2	2000mm
Roof support, bottom side rails	2	1060mm
	2	1000mm

Cut 25 x 25mm square tubing to length with angle grinder and cut off wheel ensuring that all cuts are square. Alternatively, your steel supplier can provide tubing cut to size and give you clean accurate burr free joints that are easy to weld.

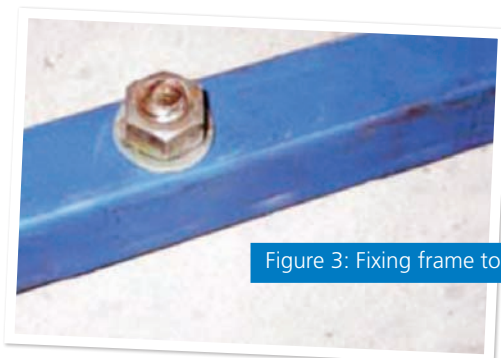

Figure 3: Fixing frame to concrete

3

Step 3 - assembling the steel frame

Welding

Lay out the components for the front frame on a flat surface and tack weld the joints.

Check the joints are square with a roofing square and finish the welds. Make up a door to suit the opening. Lay the door in position and fix to the doorframe by welding hinges and latch.

Using this finished frame as a jig, lay out the back frame components on top and weld the joints.

To join the front to the back it is best to enlist another pair of hands to hold everything in position. Weld the two bottom rails in position, and gently tip the structure on its side and weld the roof joints, continually checking for square as you go. Now weld in the internal brackets for fixing points for beds, climbing ramps, feed or water stations.

The structure may appear a little unstable at this stage, but there is no need to worry, as the cladding will provide adequate bracing when fixed. Check all joints and grind off any excess welds and burrs. Prime the joints with metal primer and then finish with a good exterior paint.

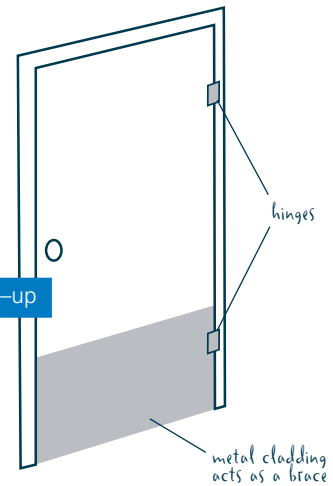

Figure 4: Door close-up

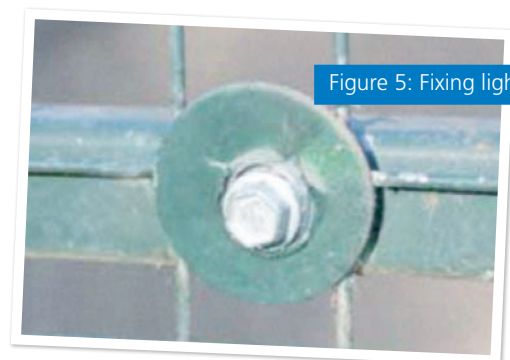
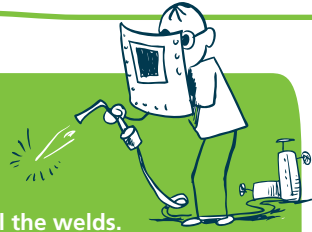

Figure 5: Fixing light mesh

Welding tips

- Have water handy when welding to cool the welds.
- A welding magnet can be used to hold components in place when tack welding joints.
- If you are using an arc welder then pick off the slag from the welded joint as you go and re weld where necessary.
- If you live in a coastal area specify a salt resistant sheet steel cladding.



Alternative to welding

When using prefabricated joiners, see Figure 1–p17, follow the same construction order, fixing each joint as you go. Use self drilling Tek screws or bolts to attach the door hinges, latch and fittings and finish the frame with a good quality exterior paint.

4 Step 4 - installation

If fixing on a concrete base, first check it is square by measuring corner to corner.

See "Cat enclosure attached to an existing structure", (Construction Step 1), for an example of a stringline set out. Fix the bottom rails with 8mm Dyna-Bolt. See Figure 3.

Where there is no concrete base, fix the frame directly to the ground with tent pegs driven through holes drilled in the bottom rail.

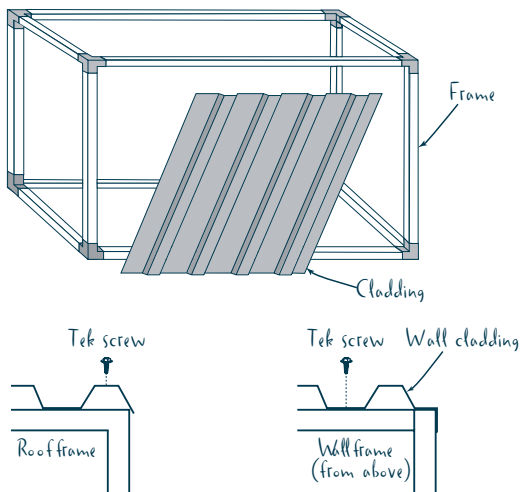

Figure 6: Cladding

5 Step 5 - door

If you find the finished door lacks rigidity, clad the bottom section with metal cladding to act as a brace. The hinges and latch are fitted to the frame on the outside with welds or self drilling Tek screws. See Figure 4. Give some thought to a childproof locking system.

6 Step 6 - cladding

Establish the shelter requirements for your base unit and plan which areas will be covered with sheet steel and with wire mesh.

Mesh

Cut each metal mesh panel to size and fix with self drilling Tek screws and washers. See Figure 5. Do not fix the edges that will be later covered with the steel cladding.

Sheeting

Calculate the sheet sizes required, bearing in mind that the standard cover is 760mm per sheet. The material is available in a range of stock lengths that you can cut to size with an angle grinder and cut off wheel. The cladding is fixed with self-tapping Tek screws and a cordless drill. Fix the first panel along the upright steel corner frame and check that the frame is square and then clamp the panel to the horizontal rails. Check again and then fix these edges with the Tek screws. Continue fixing around the frame until completed. See Figure 6.



Roof

Measure the roof opening from corner to corner to check for square and fix the roof panels across the narrow width. When affixing roof sheets, tek screws must be used on the high points of ridges in the roof cladding. Now cover the exposed edges of the roof cladding with 'U' section steel capping, using self drilling roofing Tek screws. See Figure 7–p19. However larger enclosures may require extra roof support.

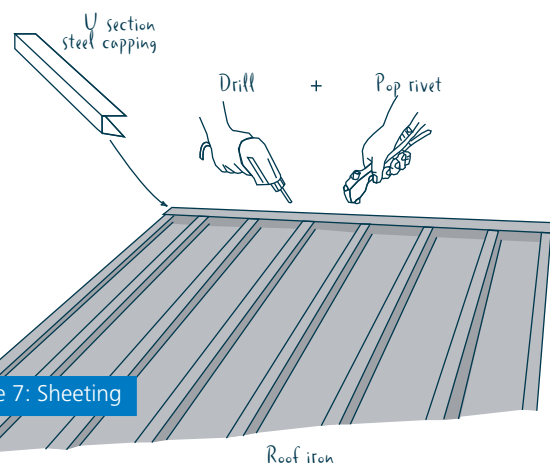

Figure 7: Sheeting

Auxiliary mesh enclosures

Tools:

- tape measure;
- f clamps;
- bolt cutters 450mm;
- roofing square;
- angle grinder;
- hammer;
- pliers with wire cutter.

Materials:

- 50 x 50mm galvanised weldmesh;
- dog clips;
- tent pegs or masonry plugs;
- hardwood post 50x50mm;
- galvanised tie wire.

These freestanding units are constructed from 50 x 50mm galvanised welded mesh, wired together with galvanised tie wire. The size and shape of each enclosure will depend on your requirements and also the stock sizes of mesh that is available from your supplier. Common sheet sizes are 2400 x 1200mm, 2000 x 1200mm and 3000 x 2400mm.

See Figure 10 for an example of a finished free standing cat enclosure, including an auxiliary unit.

1 Step 1 - design and construction

Obtain a list of stock sizes from your local steel supplier and design the modules around these to minimise off cuts.

Cut the mesh with an angle grinder or bolt cutters and grind off sharp protrusions.

Tie the panels together with tie wire. As cats do not dig deep enough to escape there is no need for a floor panel, and the enclosure can be held in place with either tent pegs or masonry plugs.

For a door simply cut a small opening and cover with an oversize piece of mesh hinged on one side with tie wire or netting clips. The hinged door (which should open inwards) can be latched closed, with spring loaded clips (dog clips). See Figure 8. Depending on how flexible the mesh is, secure the door with multiple clips to prevent the cat squeezing through gaps. The entire lid panel can be hinged to allow easy access.

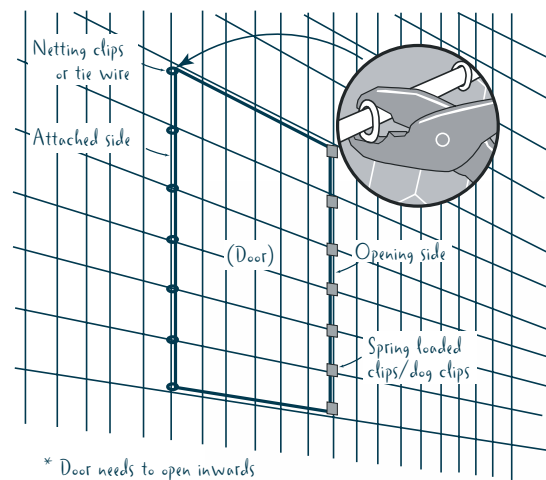

* Door needs to open inwards
 ** Enough dog clips to secure door needed so cat can't squeeze through gaps in flexible mesh

Figure 8: Design and construction of door

Door needs to open inwards.

** Enough dog clips to secure door needed so cat can't squeeze through gaps in flexible mesh.

2 Step 2 - fittings

Each enclosure should provide a hardwood scratching pole, which can be fixed to an internal wall with tie wire, and at least two levels joined by a climbing plank (platforms can either be supported by a stand or wired to the structure).

3 Step 3 - access tunnels

The individual units are interconnected by tunnels, which can also be connected to the house via a cat door. See Figure 10 for an example of a finished free standing cat enclosure, including tunnels.

These tunnels are made by folding a 900mm wide length of weldmesh and anchoring it to the ground. Either bend the 900mm wide weldmesh in an arch and fasten across the bottom with tie wire, or bend two right angles with the aid of a jig made from two lengths of hardwood and clamps. See Figure 9. If a tunnel is to be suspended, the floor is made from 300mm wide lengths of steel cladding wired to the bottom of the tunnel with tie wire.

The tunnels are wired to the component units and all protruding wire ends folded back out of harms way.

To give your cat an entertainment centre, put a birdbath within view outside the enclosure. It doesn't seem to worry the birds and will provide hours of entertainment.

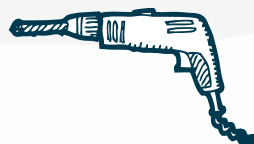

Figure 9: Tunnel bending

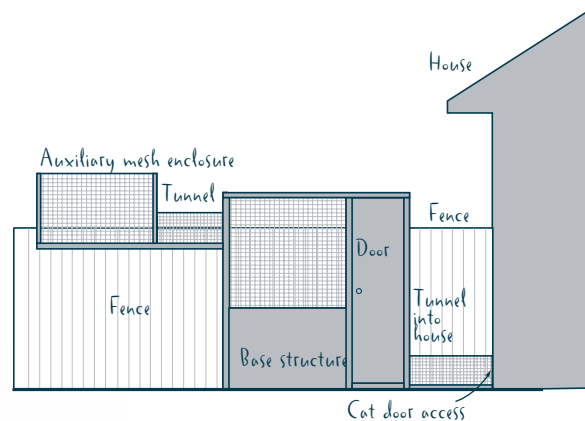

Figure 10: Sketch of finished free standing enclosure (base unit, auxiliary enclosure + tunnels)

Note: Figure 10 shows the basic building structure prior to the addition of other features (platforms, climbing planks, scratching posts, beds etc) as described in the text.



This publication is funded by the Queensland Government as part of a Gold Coast City Council pilot project to prevent stray cats.

Gold Coast City Council Animal Management is taking the lead in educating and protecting our community and environment.

All cats over the age of three months must be registered. Registration expires 31 August every year. If you have acquired a cat or dog since 1 July 2009 it must also be micro-chipped.



Pet registration fees fund a range of Council services.

- Registration tags.
- A lost and found service; giving your cat the best chance of being reunited if it becomes impounded or lost.
- Responding to complaints including wandering or roaming animals; and investigations into complaints regarding aggressive dogs.
- Educational programs that include visits to schools, kindergartens and other community events to help promote responsible pet ownership of all pets.
- Provide infrastructure for pet owners, ensuring the safety of pets, the community and our environment

For more information about pet ownership in the city please contact Council's Animal Management Department **5581 6664** or visit council's website **goldcoastcity.com.au/animals**

For advice about and displays of cat safe fencing, call or visit the Animal Welfare League of Queensland.

Shelter road, Coombabah **5509 9000**
Rossmans road, Stayplton **3807 3782**
or go to **www.awlqld.com.au**